

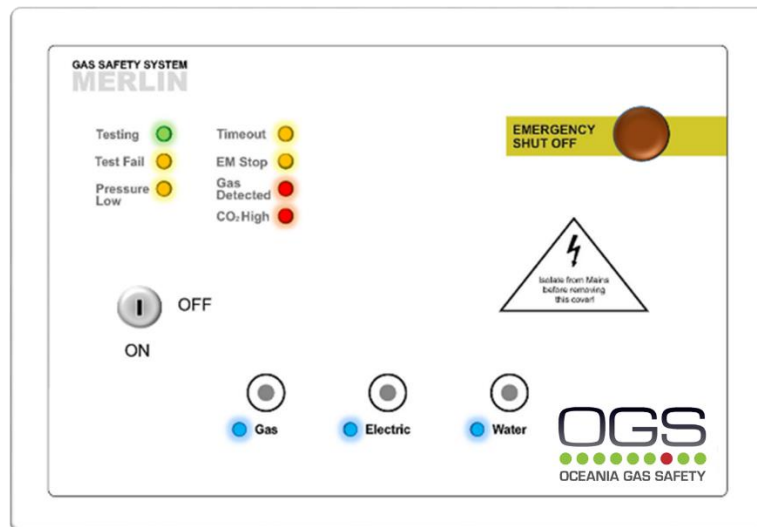

Merlin 1000VW+

Gas, Electric & Water Isolation Controller with Ventilation Interlocking



Installation, Operation & Maintenance

Please read this manual carefully and retain for future use.

For specific requirements that may deviate from the information in this guide – contact your supplier.

Oceania Gas Safety

www.oceaniagassafety.com

Contents









Important Warning Statements	3
Installation	4
Typical Application & Location	4
Mounting & Cabling	4
Circuit Board Connections Overview	5
Switch Settings – Auto RST (Panel Auto Reset)	9
Switch Settings – Pressure (Gas Pressure Threshold Configuration)	9
Switch Settings – EM SEL (Fan Switch Configuration)	9
Switch Settings – Fill Time (Gas Proving Setting)	9
Switch Settings – Time 1 & 2 (Automatic System Timeout Period)	10
Switch Settings – Mode (Ventilation Interlock Mode)	10
Automatic System Shutdown – Selectable Electrical/Water Supply	10
Operation	11
Initial Power Up	11
LED Indicators	11
Maintenance	12
Specification	12

Important Warning Statements



Warning Symbol!

Where this symbol is used, the manual must be consulted to understand the nature of any potential hazards and how to avoid them.

-  **Please take the time to thoroughly read this user's guide which should be retained for future reference.**
 -  **It is recommended that this device be commissioned upon installation.**
 -  **Do not apply lighter gas or other aerosols to detectors – this will cause extreme damage to the gas sensing elements.**
 -  **High concentrations of alcohol found in many products may damage, deteriorate, or affect the gas sensing elements of the detectors – Avoid exposure near your devices.**
 -  **Never ignore your devices when in alarm. Actuation of your alarm indicates the presence of an error or issue that requires immediate attention.**
 -  **This device requires a continual supply of electrical power – it will not work without power.**
 -  **This device should not be used to substitute proper installation, use and/or maintenance of fuel burning appliances including appropriate ventilation and exhaust systems.**
 -  **Your product should reach you in perfect condition, if you suspect it is damaged, contact your supplier.**
-

Manufacturer's Warranty

Warranty coverage: The manufacturer warrants to the original consumer purchaser, that this product will be free of defects in material and workmanship for a period of three (3) years from date of purchase.

The manufacturer's liability hereunder is limited to replacement of the product with repaired product at the discretion of the manufacturer. This warranty is void if the product has been damaged by accident, unreasonable use, neglect, tampering or other causes not arising from defects in material or workmanship. This warranty extends to the original consumer purchaser of the product only.

Warranty disclaimers: Any implied warranties arising out of this sale, including but not limited to the implied warranties of description, merchantability and intended operational purpose, are limited in duration to the above warranty period. In no event shall the manufacturer be liable for loss of use of this product or for any indirect, special, incidental, or consequential damages, or costs, or expenses incurred by the consumer or any other user of this product, whether due to a breach of contract, negligence, strict liability in tort or otherwise. The manufacturer shall have no liability for any personal injury, property damage or any special, incidental, contingent or consequential damage of any kind resulting from gas leakage, fire, or explosion. This warranty does not affect your statutory rights.

Warranty Performance: During the above warranty period, your product will be replaced with a comparable product if the defective product is returned together with proof of purchase date. The replacement product will be in warranty for the remainder of the original warranty period or for six months – whichever is the greatest.

Information on waste disposal for consumers of electrical & electronic equipment.





When this product has reached the end of its life it must be treated as Waste Electrical & Electronics Equipment (WEEE). Any WEEE marked products must not be mixed with general household waste, but kept separate for the treatment, recovery and recycling of the materials used. Please contact your supplier or local authority for details of recycling schemes in your area.



At the end of their working life, electrochemical sensors should be disposed of in an environmentally safe manner. Alternatively, they can be securely packaged and returned to OGS clearly marked for disposal. Electrochemical sensors should not be incinerated as this may cause the cell to emit toxic fumes.

Installation

Typical Application & Location







-  **Installation must be carried out by a licenced, insured contractor!**
-  **Ensure that detectors are not exposed to liquid or dust contamination!**
-  **Cables must be protected against mechanical damage!**
-  **Please refer to your detector manual for important information regarding coverage, location and positioning including areas and conditions to avoid.**

The Merlin 1000VW+ gas pressure proving, and electric isolation system with ventilation interlocking between the ventilation system and the gas solenoid valve. The system is compatible with both current monitors and air pressure differential switches to interlock with up to two fans.

This panel is to be used to carry out a gas proving test on the pipe work to highlight if there is a gas appliance open or a gas leak in the laboratory. The Merlin 1000VW+ is designed to give the user full control over the incoming gas supply, bench electrics and water supply with the lockable main key-switch.

The Merlin 1000VW+ can work in conjunction with carbon dioxide, natural gas, carbon monoxide and LPG sensors. The Merlin 1000VW+ also has a built in “timeout” facility which will automatically shut off the gas solenoid valve at the end of a specific time, this time can be adjusted to 45mins, 1.5, 3 hours or can be overridden if required.

Mounting & Cabling

-  **If mounting direct to wall - ensure the wall surface is flat to prevent base distortion!**
-  **Ensure the rear base is installed in the correct orientation as shown!**
-  **Where cable glands/conduits are used for wire entry, use 20mm (3/4 inch) max separated by at least 20mm!**
-  **Any parts that form part of the connections/installation must have a minimum fire-retardant rating of UL94v-2!**
-  **Damage to PCBs when creating cable entry points may void any warranty!**
-  **Restrain the hazardous live wiring from accidental loosening to prevent wires from moving after installation and touching parts of opposite polarity or at low voltages!**
-  **Isolate the equipment from all hazardous live power sources before opening the cover!**

1. Carefully remove the front cover from the unit by unscrewing the four bolts located at each corner. To do this – use the socket wrench provided.
2. Remove the keys and spare parts - keep safe.
3. Mark the four screw holes located on the back of the enclosure to the wall. Ensure the wall surface is flat to prevent base distortion. Drill out as necessary ensuring all swarf is removed from the box and holes have smooth edges.
4. After executing the mounting and the connections –replace the front cover and insert the security caps over the four bolts.

Circuit Board Connections Overview

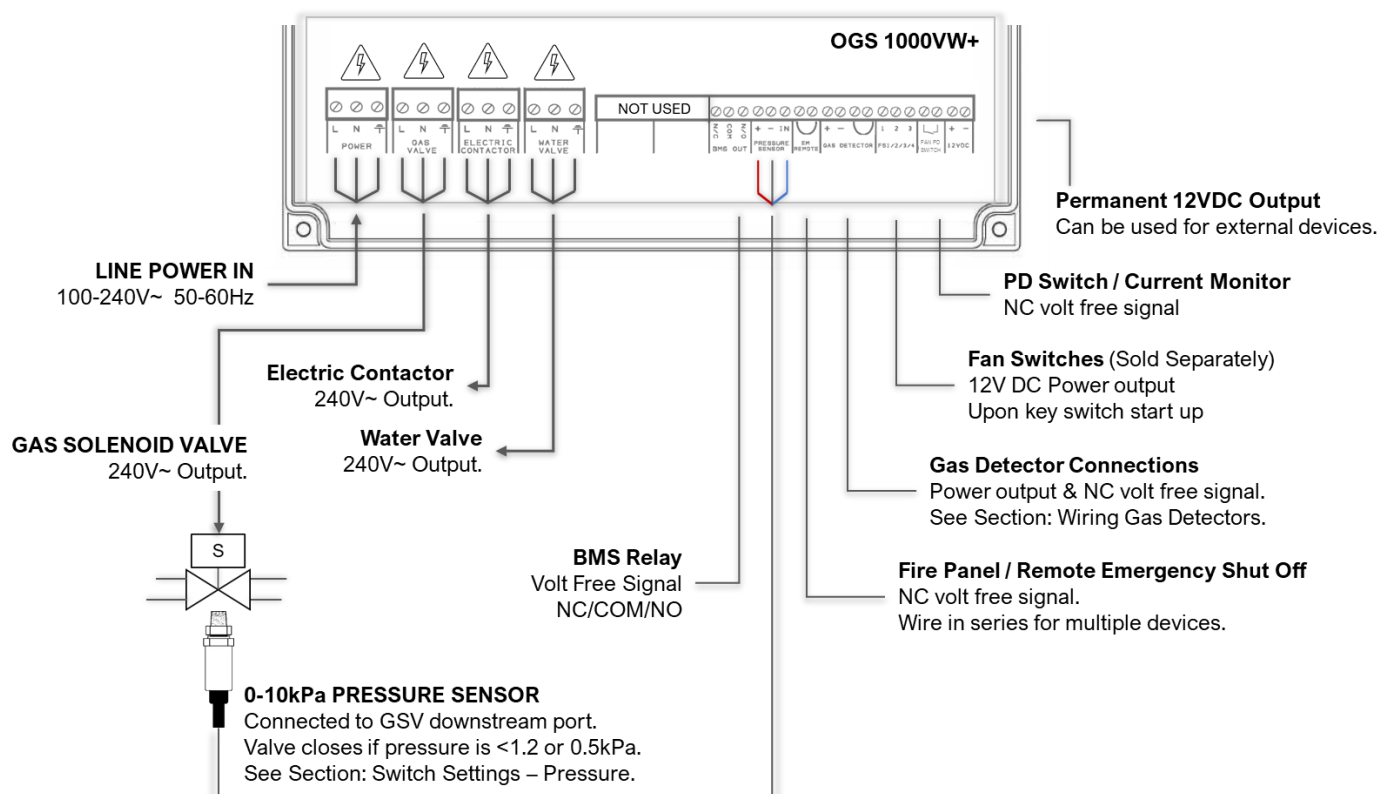

MAINS POWER IN

100-240V~ Mains Power should be supplied to the [POWER / LINE IN] terminal and fused at 3A.

On connecting the mains supply to the panel, the red power LED indicator will light up – this is located on the front cover (OGS Logo).

GAS VALVE OUTPUT

100-240VAC electrical power supplied from the [VALVE OUT] connector using a 3-core cable can be connected to a gas solenoid valve which can shut the gas supply on alarm status.

Refer to your valve manual for more information and wiring!

ELECTRIC CONTACTOR & WATER VALVE OUTPUT

240VAC electrical power supplied from the [ELECTRIC CONTACTOR] and [WATER VALVE] connectors using a 3-core cable. Refer to contactor and/or water valve manuals for more information and wiring!

BMS OUT

Connections are available on the board for Building Management Systems.

[NO Normally Open] [COM Common] [NC Normally Closed]. These are volt free connections.

This is a relay that changes state when the gas is on/off and can be used in conjunction with the 12V DC output and other external relays that affect other devices and controls such as purge fans and audible alarms etc.

PRESSURE SENSOR

- ⚠ Pressure sensors should be screwed to the downstream port of the valve.
- ⚠ Pressure Sensors are tested and certified to AS 4628/2005.

The pressure sensor is wired to the [PRESSURE SENSOR] connector and screwed into the downstream port of the gas solenoid valve. Connect the pressure sensor: Wiring: Red **[+]** Black **[-]** Blue **[IN]**

The sensor will monitor the gas supply pressure and if pressure drops below 0.5 or 1.2 kPa – the gas valve will close. See section; Switch Settings - for Pressure options

EM REMOTE / FIRE PANEL

Connections for remote emergency shut-off buttons or integrated with a fire alarm to close the gas supply automatically in the event of a fire. This is linked out as a factory setting.

Remote emergency shut-off buttons should be dry contact and wired to the using a plenum security cable, white, 18/2 (18AWG 2 conductor), stranded, CMP or similar.

WIRING GAS DETECTORS

- ⚠ Refer to your gas detector manual for further information!
- ⚠ If no detector is being used leave the factory fitted link in!

Connecting a Merlin Gas Detector i / i-S

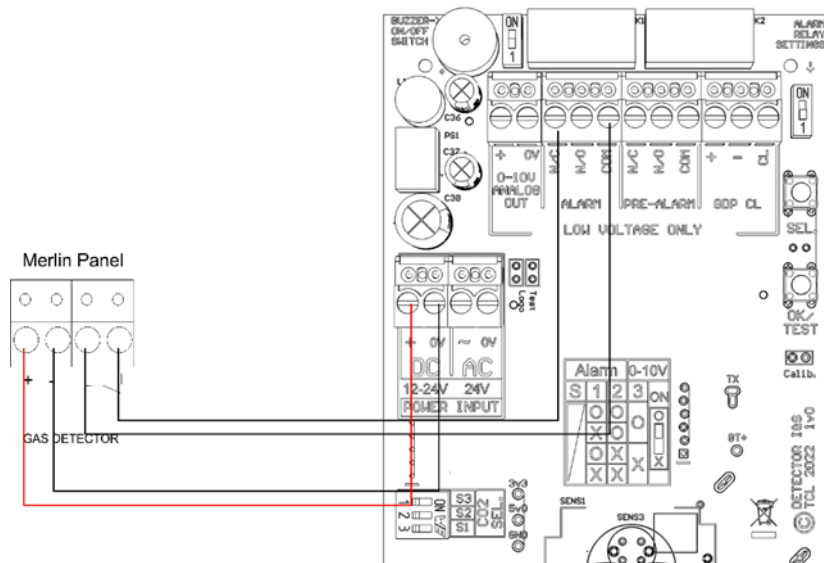

Connecting a Merlin Gas Detector

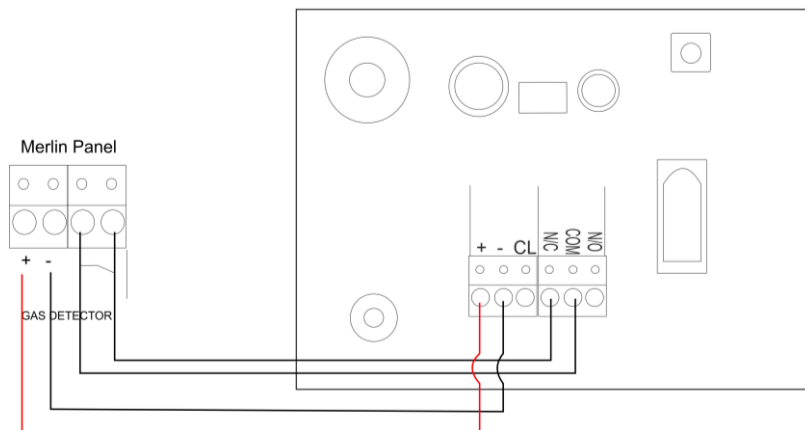

Connecting a Merlin Gas Detector X

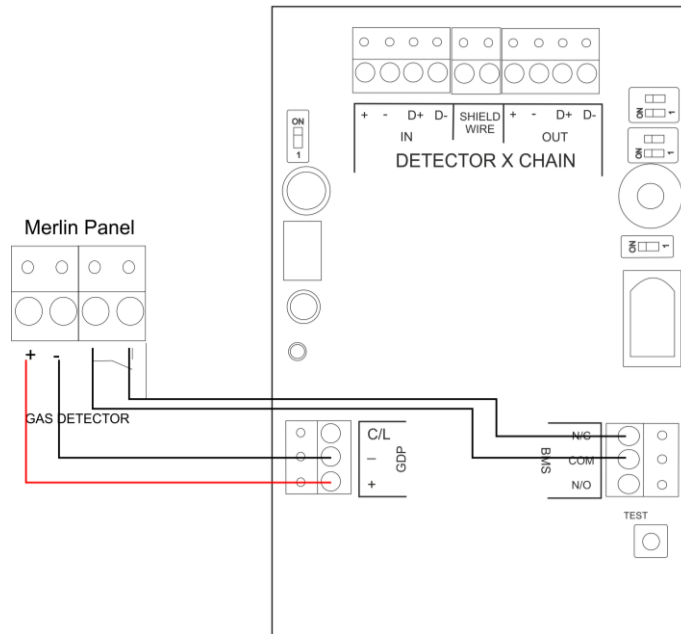

Connecting a Merlin CO2X

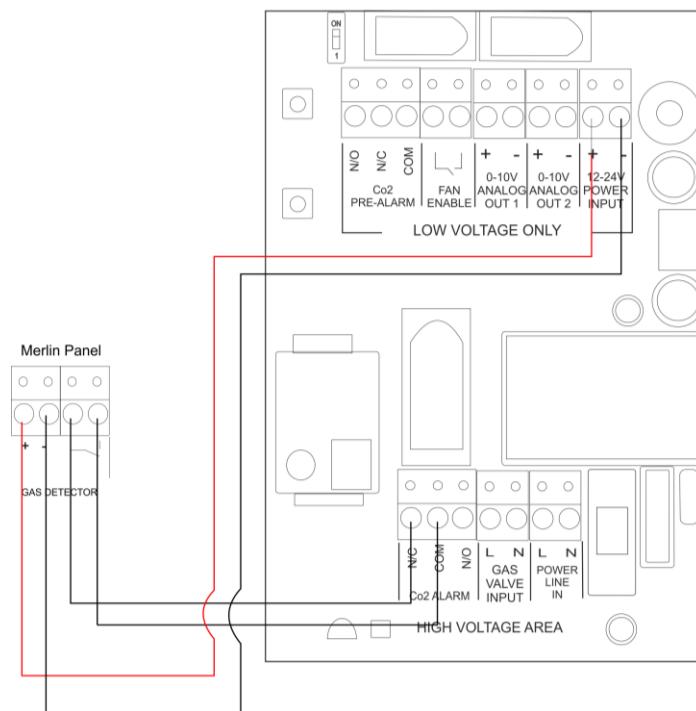

FAN SWITCHES

This terminal, switches when the key is turned on and off.

This can be connected to a fan switch (supplied separately) which can provide power to fans when the control panel is switched on.

PD SWITCHES / CURRENT MONITORS

This terminal is used to receive an input signal from external air pressure switches or current monitors. This terminal is linked out as a factory setting.

Wiring to external air pressure switches or current monitors should be made using a two-core cable. This is a volt free connection.

PM2+.

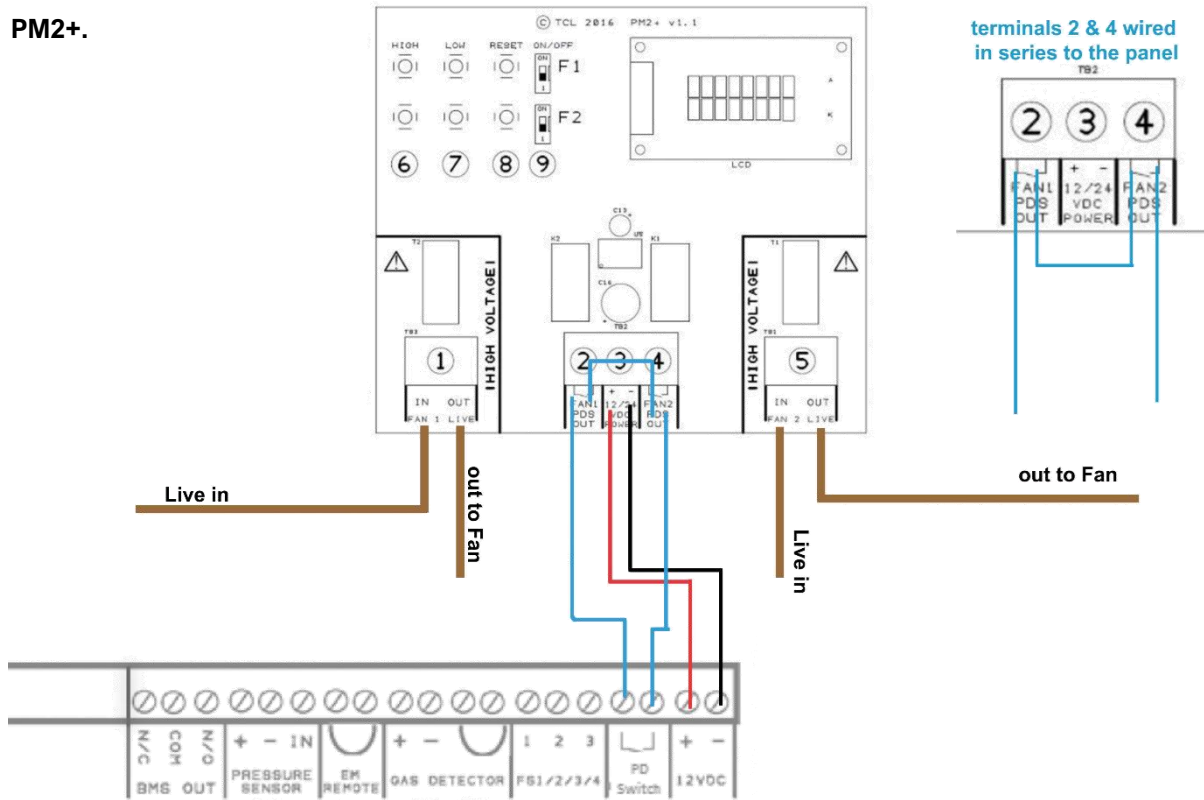

Air Pressure Switch

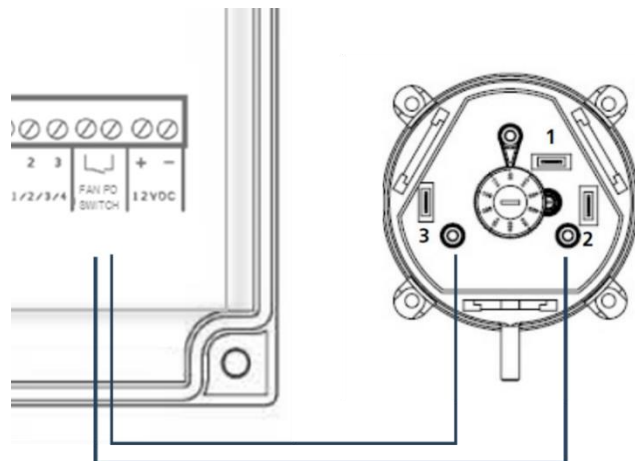

12V DC

This is a power output for external auxiliary devices when there is power at the panel and can be used to create a relay switch with the BMS relay output. Max output: 50mA

Switch Settings – Auto RST (Panel Auto Reset)

There are various dipswitches on the front circuit board that can be adjusted to configure your system as per the following. There is a switch located on the circuit board labelled [AUTO RST].

OFF	When power is restored after the power cut/ loss, the panel must be restarted manually. (Default)
ON	This will instruct the system to restart automatically when power is restored after power cut/loss.

Switch Settings – Pressure (Gas Pressure Threshold Configuration)

There is a dipswitch located on the circuit board labelled [Pressure].

The gas supply will be turned off if pressure will drop below threshold value continuously for 10 secs.

OFF	Low pressure threshold is set to 1.2 kPa. (Default)
ON	Low pressure threshold is set to 0.5 kPa.

Switch Settings – EM SEL (Fan Switch Configuration)

 **This option is not available if a fan switch is not installed!**

A fan switch (Merlin FS1 or FS2 - sold separately) provides the facility to turn on fan(s) when the 1000VW+ panel is switched on and removes power to fan(s) when the switched off.

OFF	Instructs the system to shut down fan(s) and gas upon activation of emergency shut off button(s). (Default)
ON	Instructs the system to leave the fans on and shut off the gas supply only upon activation of emergency shut off button(s).

Switch Settings – Fill Time (Gas Proving Setting)

FILL TIME: Amount of time the gas valve opens to fill the gas line on power up or reset.

PROVE TIME: Amount of time the system tests the gas line for leaks on power up or reset.

OFF	FILL 5 Seconds, PROVE 30 Seconds (Default)
ON	FILL 10 Seconds, PROVE 50 Seconds

Switch Settings – Time 1 & 2 (Automatic System Timeout Period)

 Upon timeout the gas supply will be turned off.

There are two dipswitches [Time 1 & Time 2].

The system has an auto-shut down feature after a selected time. These can be configured to select the required timeout/ shut-down period.

TIME 1	TIME 2	Timeout Period
OFF	OFF	45 minutes (Default)
ON	OFF	1.5 Hours
OFF	ON	3 Hours
ON	ON	Disabled

Switch Settings – Mode (Ventilation Interlock Mode)

There are 2 operating modes of ventilation interlock.

MODE 1

The panel is simply looking for a closed circuit from the air pressure differential switch, once the panel has a closed signal, the gas will come on. If the circuit is then opened the gas valve will close.

MODE 2

The Panel needs to see a change in state of the pressure differential switch. Once the switch has gone from open to closed, the gas will come on. If the switch is already closed system will wait for the switch to open, then close again before allowing the gas on. If the circuit is then opened the gas valve will close.

OFF	MODE 1 (Default)
ON	MODE 2

Automatic System Shutdown – Selectable Electrical/Water Supply

There is a switch located on the circuit board labelled [ELECTR] & [WATER]. These are factory set to 'Off'. Upon installation, they can each be switched 'On' - This will instruct the system to also turn off Electrical and/or water supply when performing auto-shut down/ timeout or in the event of an emergency shutdown.

Operation

Initial Power Up

 **All services can be turned on or off within 10 seconds only of the key switch being turned on. After 10 seconds, all utility buttons will be disabled. The user must turn the key off and back on to adjust any services.**

On connecting mains power, an LED on the front of the panel (OGS Logo) will illuminate red.

1. Turn the key switch to on position.
2. Gas, Electric and Water LEDs will flash for 10 seconds.
3. Press relevant service button to turn required utility on.

LED Indicators

- **Gas**

When the key switch is turned on, the system will check the installation for gas leaks.

If gas proving is successful, the LED will illuminate. **ON = Gas On / OFF = Gas Off**

- **Electric**

When electric service is turned on, the Electric LED will illuminate.

ON = Electric on / FLASHING = Electric Off, Electric button enabled / OFF = Electric Off, Electric button disabled.

- **Water**

When water service is turned on, the Water LED will illuminate.

ON = Water on / FLASHING = Water Off, Water button enabled / OFF = Water Off, Water button disabled.

- **Testing**

This LED will illuminate GREEN for approximately 30 seconds when the panel is checking the integrity of the gas installation upon start up. **ON = proving the gas line, do NOT operate any appliances.**

- **Test Fail**

Under normal working conditions this LED is off. When the panel detects a gas leak on start-up, the LED will illuminate AMBER. Gas valve will remain closed. **OFF = OK / ON = gas proving failed.**

- **Pressure Low**

Under normal working conditions the LED is off. The LED illuminates AMBER when pressure of the gas supply drops below threshold for 10 secs & the gas valve closes. **OFF = OK / ON = gas supply pressure low.**

- **Timeout**

Under normal working conditions this LED is off. This LED will illuminate AMBER when auto-shut down has occurred. **OFF = OK / ON = Auto-shut down activated**

- **EM Stop**

If an emergency shut off button (either remote or on the panel) is pressed, the LED will illuminate AMBER and the gas will be turned off. The emergency shutoff button must be reset before restarting the system. **OFF = OK / ON = Emergency Shut-Off button activated.**

- **CO2/ Gas Detected**

Under normal working conditions this LED is off. If the external Merlin detector connected detects gas this will show RED, and the gas valve will turn off. **OFF = OK / ON = Gas detected.**

- **Fan Fault**

Under normal working conditions this LED is off. If a fan fault is identified for longer than 10 seconds the LED will show RED, and the Gas valve will turn off. Fan fault will only identify when the gas is on only. **OFF = OK / ON = Gas supply has been shut off due to a ventilation fault.**

Maintenance

Keep your panel in good working order - follow these basic principles.

- Remove any dust/debris from the outer enclosure regularly using a slightly damp cloth.
- Never use detergents or solvents to clean your device.
- Never spray air fresheners, hair spray, paint or other aerosols near the device.
- Never paint the device. Paint will seal vents and interfere with the device.

Specification

General	
Model:	1000VW+
Size: (H x W x D)	7.08 x 10.03 x 3" (180 x 255 x 77 mm)
Housing Material:	ABS Polyloc - PA765. UL 94 V-1
Mounting:	Indoor use - Wall Mounting
User Interface	
Visual Indicators:	LED
Audible Alarm:	>70dB @ 3.28ft (1m). Quiet conditions.
Language:	English
Power Supply	
Power Rating:	6W max.
Voltage Rating:	100-240V~ 50-60Hz
Internal Fuse:	T3.15A L250V
Equipment	
Overvoltage Category:	II
Pollution Degree:	2
Equipment Class:	2
Environmental	
Ingress Protection:	Not Formally Evaluated
Operating:	-10 ~ 50°C / 14 ~ 122°F 30 ~ 80% RH (non-condensing)
Storage:	-25 ~ 50°C / -13~122°F up to 95% RH (non-condensing)
Altitude Rating:	2000m
Wiring	
Typical	Power~#18-12AWG-Tinned Copper. Current Rating: 1A Minimum Relay: ~#18-12AWG-Tinned Copper. Current Rating: 10A Minimum For field connections use wires suitable for at least 90°C (194°F) Detector: #15AWG Power Pair Other: #18-14AWG-Tinned Copper.
Approvals	
Electromagnetic Compatibility and Electrical Safety (CE / UKCA)	IEC 61010-1:2010 EMC EN 61326-1:2013
Pressure Sensor	AS 4628/2005

Every effort is made to ensure the accuracy of this document; however, OGS can assume no responsibility for any errors or omissions in this document or their consequences. OGS would greatly appreciate being informed of any errors or omissions that may be found in the content of this document. For information not covered in this document, or if there is a requirement to send comments/corrections, please contact OGS using the contact details.

www.oceaniagassafety.com

Tuakau Waikato
New Zealand
+64212386990



Oceania Gas Safety is the owner of this document and reserves all rights of modification without prior notice.